

mardeco[®]

ARCHITECTURAL HARDWARE

MARDECO M-SERIES REFINED SLIDING DOOR HARDWARE



About Mardeco International

Mardeco International Ltd. is a privately owned company based in Auckland, New Zealand, specializing in importing and exporting high-quality architectural hardware. For over 23 years, we've connected global designs with industries worldwide, working with kitchen and furniture manufacturers, hardware wholesalers, retailers, architects, interior designers, and homeowners.

Our products have been selected for projects across New Zealand, Australia, the UK, Europe, South Africa, Mexico, the USA, and the Pacific Islands, reflecting our commitment to quality and reliability.

At Mardeco, we are driven by innovation. Our team has developed key products such as the M-Series sliding door hardware and S-Line handrail brackets, designed to meet the practical and aesthetic needs of modern spaces. In addition, we offer a range of trusted imported products, including Mardeco kitchen and cabinet hardware, JNF architectural hardware, CL cabinet locks, and Groël door handles.

At Mardeco, we believe in balancing great design with dependable service. We aim to help clients find the right products exactly when needed, ensuring every project is completed smoothly and stylishly.

Mardeco: Practical solutions, thoughtful design, and reliable service bringing global hardware to local spaces.

mardeco[®]
ARCHITECTURAL HARDWARE

Contents

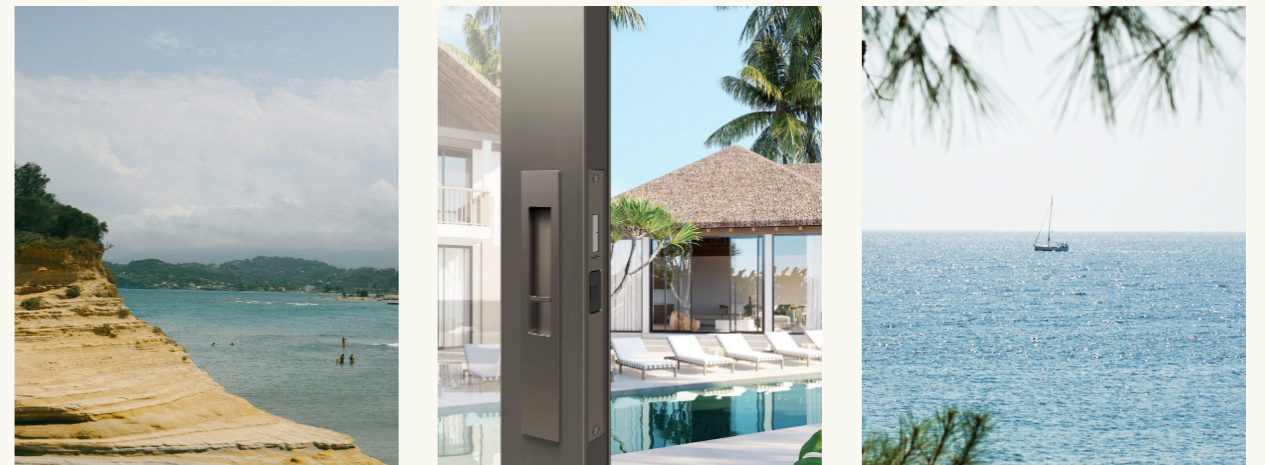

01	8000 Mardeco M-Series	6-7
02	9000 Mardeco M-Series Oval	8-9
03	8100 Mardeco M-Series Euro lock	10-11
04	8003 Mardeco M-Series Off-Set Flush Pull	12-13
05	Finishes Guide / Design Story	14-15



“Form follows function”

Lois Henry Sullivan

American Architect (1856 - 1924)

The quote means that the shape and design of a building or object should be primarily based on its intended purpose and function, rather than on aesthetic considerations alone.

Uncompromising Simplicity

The M-Series range of sliding door hardware by Mardeco represents a new age of flush pull handles and privacy locks for timber and aluminium sliding doors. Packed with innovation and sophistication, these sleek, modern handles represent simplicity through uncompromising design.

The new Mardeco 9000 Oval M-Series continues this tradition with its elegant and traditional design. This addition to the M-Series range offers a seamless blend of style and functionality, incorporating a classic style with soft lines that make it a perfect choice for any project.

Mardeco has left no stone unturned in perfecting the M-Series range. Every aspect, from the handles to the installation resources and packaging, has been meticulously designed to ensure the highest quality and ease of use.

Designed in New Zealand, the M-Series perfectly represents what Mardeco is all about... quality, design, and good service. M-Series hardware includes detailed installation instructions and additional parts for multiple applications, giving your project a cohesive look.

There are so many decisions to be made when it comes to fitting out a project, yet deciding which sliding door hardware to choose is easy with the M-Series by Mardeco.

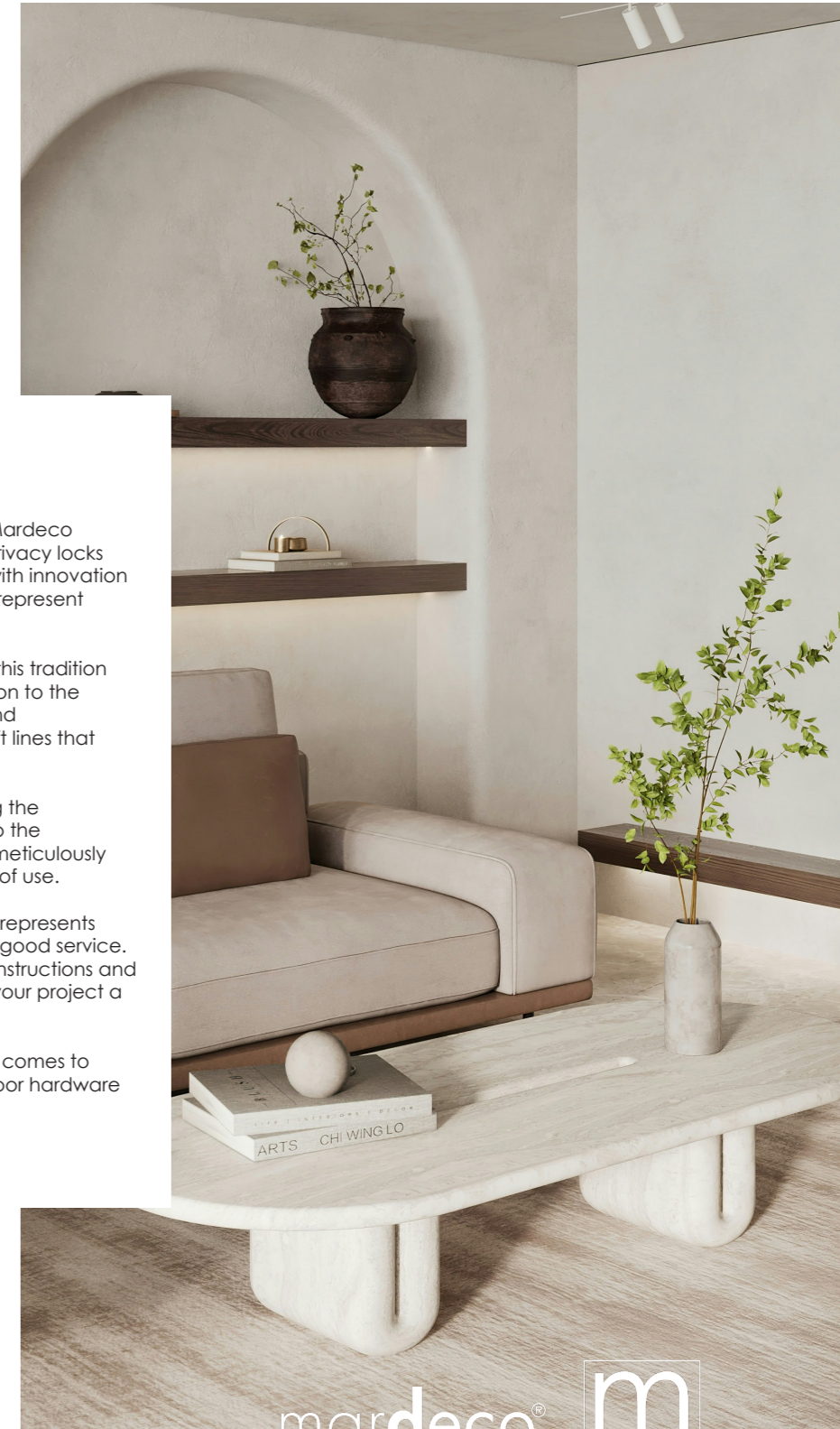

8000 Mardeco M-Series

8001/92 M-Series Recessed End Pull

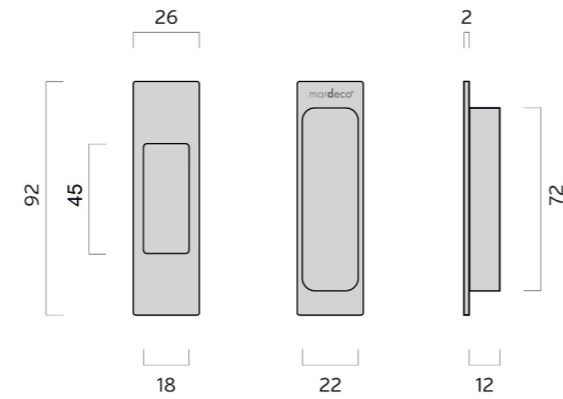
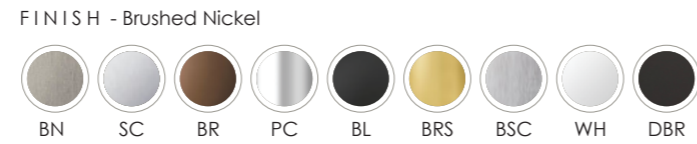

Contents:

- 1 x End Pull
- 1 x Set Fixing Components

Application: Cavity/Sliding Doors (Timber or Aluminium) Kitchen Cabinetry

8000 Mardeco M-Series

8008 M-Series Flush Pull Passage Set

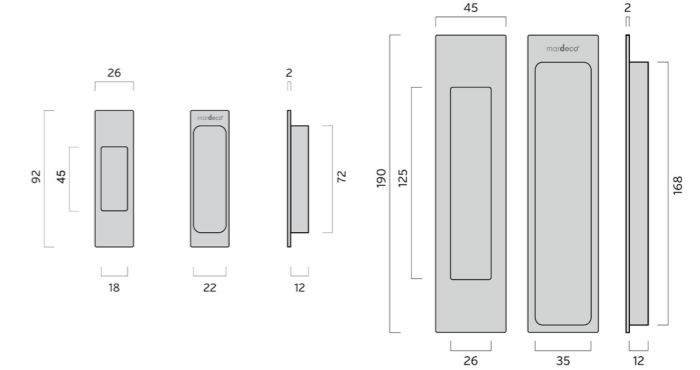
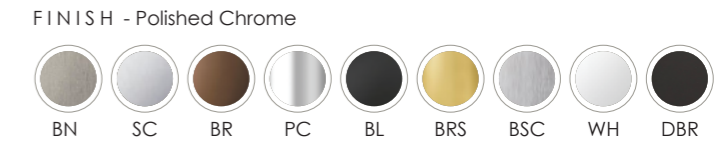

Contents:

- 2 x Flush Pulls
- 1 x End Pull
- 1 x Set Fixing Components

Application: Cavity/Sliding Doors (Timber or Aluminium)

8002/190 M-Series Recessed Flush Pull

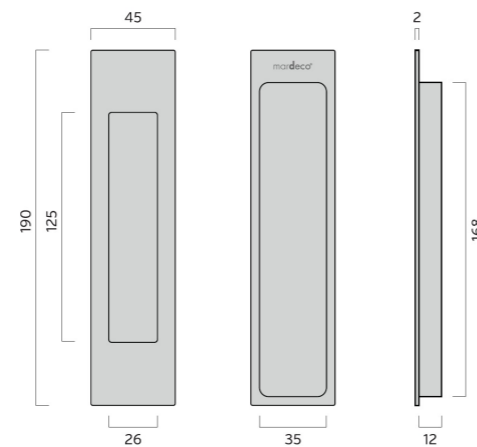
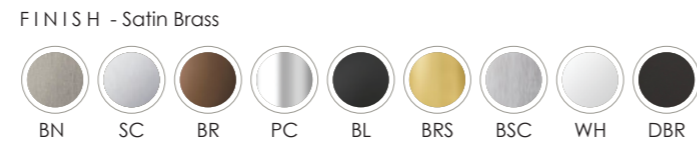

Contents:

- 1 x Flush Pull
- 1 x Set Fixing Components

Application: Cavity/Sliding Doors (Timber or Aluminium) Kitchen Cabinetry

8004 M-Series Flush Pull Privacy Set

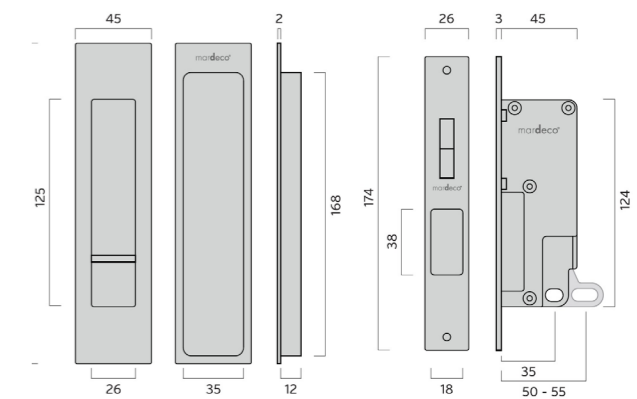

Contents:

- 1 x Flush Pull Privacy Slide
- 1 x Flush Pull Emergency Release
- 1 x Sliding Door Lock
- 1 x Striker Plate & Box
- 1 x 50-55mm solid brass backset (35mm available on request)
- 4 x spindle sizes to suit door thicknesses 34 - 50mm
- 1 x Set Fixing Components

Application: Sliding Doors (Timber or Aluminium)
8006/SET Flush Pull Privacy Set Double Privacy Snib (made to order)

9000 Mardeco Oval M-Series

9001/96 Oval M-Series Recessed End Pull

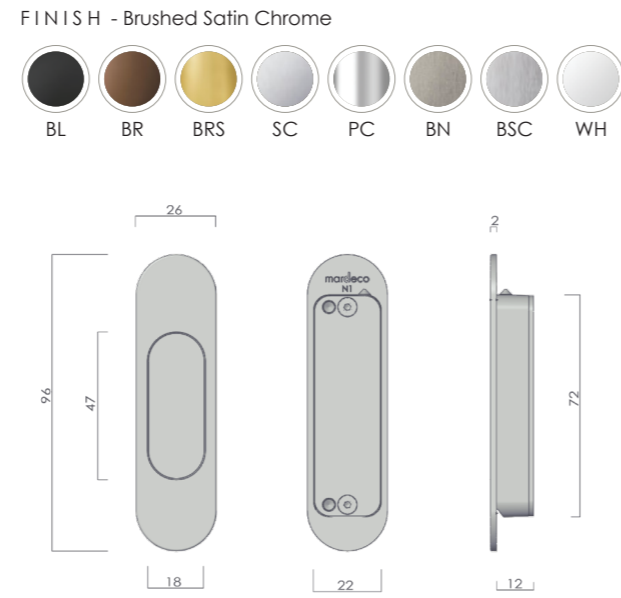

Contents:

- 1 x End Pull
- 1 x Set Fixing Components

Application: Cavity/Sliding Doors (Timber or Aluminium) Cabinetry

9000 Mardeco Oval M-Series

9008 M-Series Flush Pull Passage Set

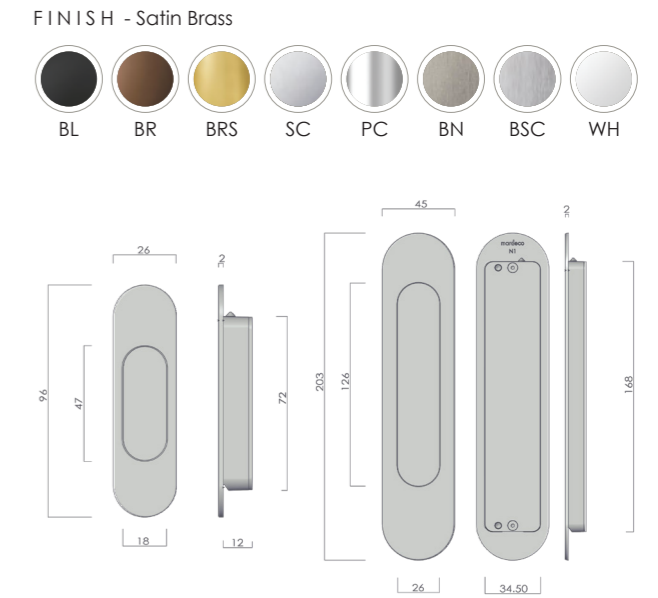

Contents:

- 2 x Flush Pulls
- 1 x End Pull
- 1 x Set Fixing Components

Application: Cavity/Sliding Doors (Timber or Aluminium)

9002/203 Oval M-Series Recessed Flush Pull

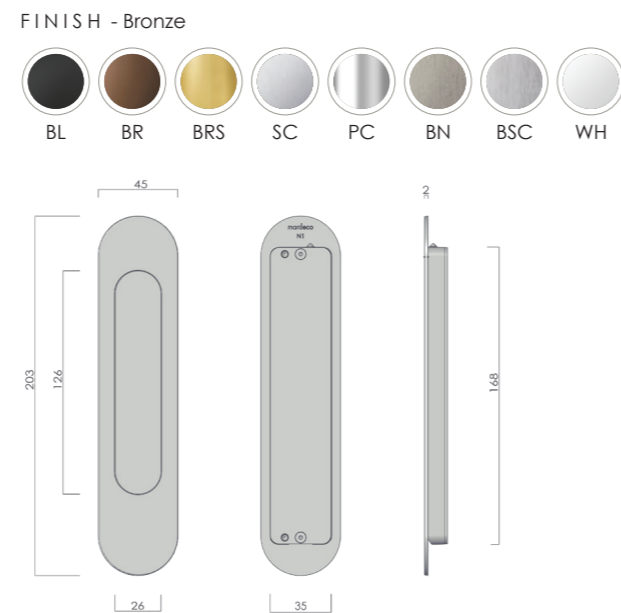

Contents:

- 1 x Flush Pull
- 1 x Set Fixing Components

Application: Cavity/Sliding Doors (Timber or Aluminium)

9004 Oval M-Series Flush Pull Privacy Set

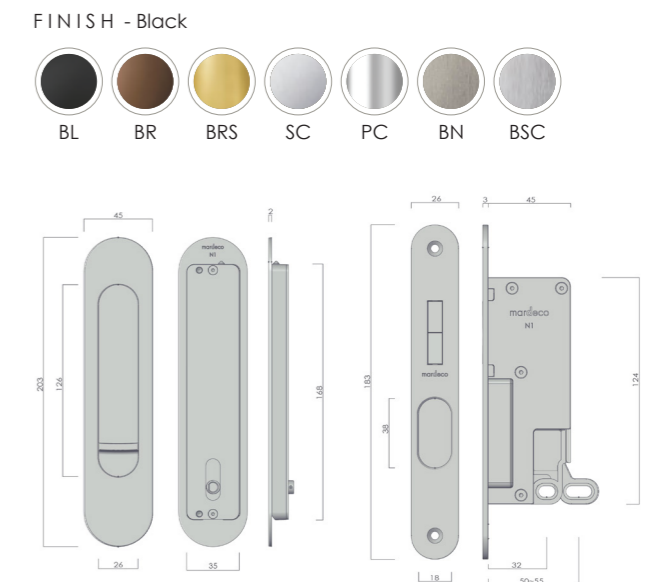

Contents:

- 1 x Flush Pull Privacy Slide
- 1 x Flush Pull Emergency Release
- 1 x Sliding Door Lock
- 1 x Striker Plate & Box
- 1 x 50-55mm solid brass backset (35mm available on request)
- 4 x spindle sizes to suit door thicknesses 34 - 50mm
- 1 x Set Fixing Components

Application: Sliding Doors (Timber or Aluminium)
9006/SET Flush Pull Privacy Set Double Privacy Snib (made to order)

Mardeco M-Series Euro lock

8104/SET M-Series Euro Lock

Exterior Euro Key Hole Plate (Euro Cylinder Sold Separately) Minimum door thickness 35mm



Application: Interior and exterior sliding doors (Timber and Aluminium)
Backset 50 55 mm

FINISH - Satin Brass

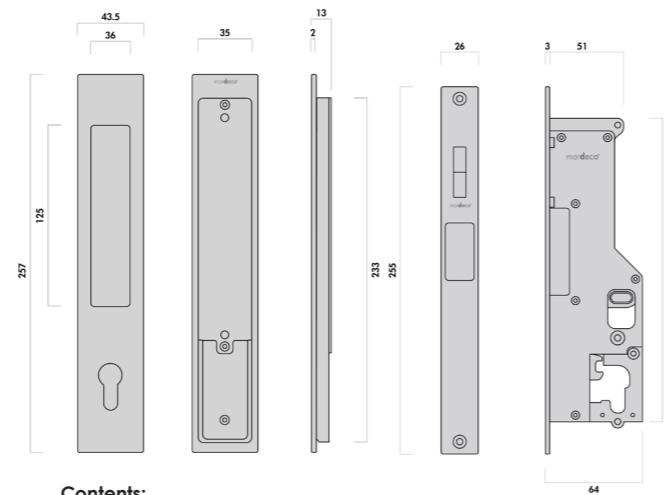

Contents:

- 1 x Flush Pull locking slide
- 1 x Flush Pull Euro keyhole
- 1 x Sliding door mortise lock
- 1 x Adjustable Striker plate & box
- 5 x Spindle sizes to suit door thicknesses 35 - 63mm
- 1 x EPDM Weather seal
- 1 x Set Fixing components

8105/SET M Series Snib Lock

Exterior Plain Plate



Application: Interior and exterior sliding doors (Timber and Aluminium)
Backset 50 55 mm

FINISH - Black

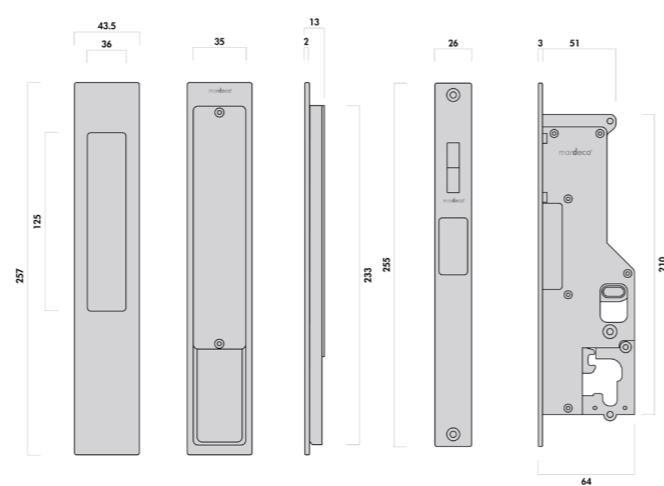

Contents:

- 2 x Flush Pull locking slide
- 1 x Sliding door mortise lock
- 1 x Adjustable Striker plate & box
- 5 x Spindle sizes to suit door thicknesses 35 - 63mm
- 1 x EPDM Weather seal
- 1 x Set Fixing components

Long Plate Flush Pull

8102 Mardeco M Series Long Plate Flush Pull

No Key Hole (Matches M-Series 8104/8105 Euro Lock Set)



FINISH - Brushed Nickel

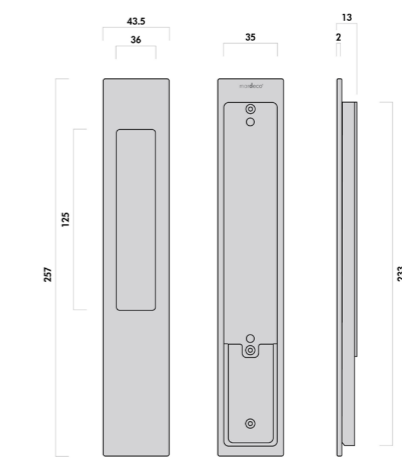

Contents:

- 1 x Flush Pull
- 1 x Set Fixing Components

Application: Interior and exterior sliding doors (Timber and Aluminium)

Mardeco C4 Euro Cylinders

4-5 Pin Euro Cylinder C4 Keyway for M-Series 8104 Euro lock KA - KD with confirmation of the door thickness. (KA = keyed alike, KD = keyed to differ)

Reverse fit Euro cylinder for larger projection possible. (door thickness from 64 - 90 mm).

Available in five finishes



8500/38

C4 Euro Cylinder 28mm CC (38mm overall) KA or KD
Suitable For Door Size: 35 - 39 mm

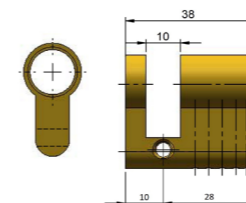

8500/40

C4 Euro Cylinder 30mm CC (40mm overall) KA or KD
Suitable For Door Size: 40 - 43 mm

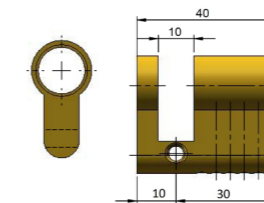

8500/43

C4 Euro Cylinder 33mm (43mm overall) KA or KD
Suitable For Door Size: 44 - 49 mm

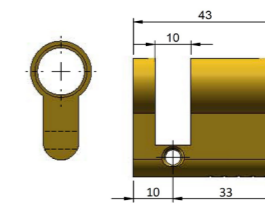

8500/50

C4 Euro Cylinder 40mm (50mm overall) KA or KD
Suitable For Door Size: 50 - 63 mm

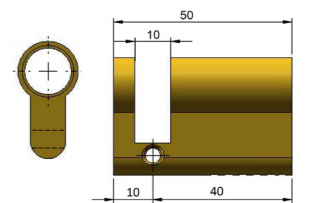

Mardeco M-Series Off-Set Flush Pull



8003 M-Series Off-Set Flush Pull

FINISH - Bronze

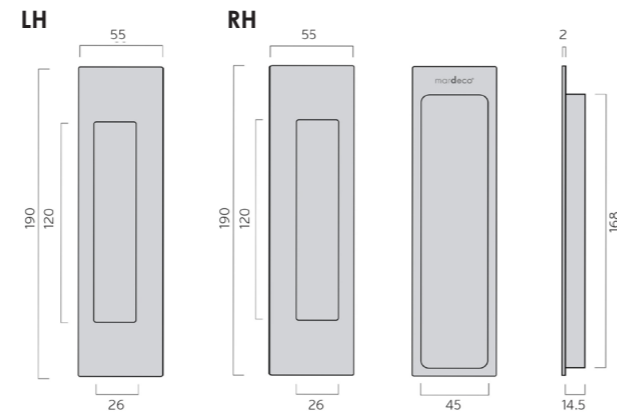

Contents:

1 x Flush Pull
1 x Set Fixing Components

8003 M-Series Off-Set Flush Pull

The 8003 Offset Flush Pull is designed for use with Bi-Fold Doors, Pivot Doors, Swing Doors and Sliding Doors. The Offset design provides an additional grip along one edge of the Flush Pull. The 8003 Series are handed and need to be ordered as a left-handed (LH) or right-handed (RH) option.

The Offset Flush Pull is suitable for an extensive range of timber and aluminium door thicknesses, and it comes with detailed installation instructions, templates and all fixings.

Designed in New Zealand, the innovative M-Series Offset Flush Pull reflects exactly what Mardeco is all about ... quality, design and good service. We believe in looking at our clients and ensuring that they can get the products they're looking for when they need them.

Application:

- Application: Bi-fold Doors, Sliding Doors, Swing Doors, Pivot doors
- Material: Zinc Alloy
- Size: 190mm x 55mm x 14.5 mm
- Projection: 2mm
- Suitable for timber and aluminium doors
- Available in 8 finishes
- Fixing components, fitting instructions and templates included in the packaging

Please note: Offset Flush Pulls are handed, left hand (LH) and right hand (RH)

mardeco[®]
ARCHITECTURAL HARDWARE

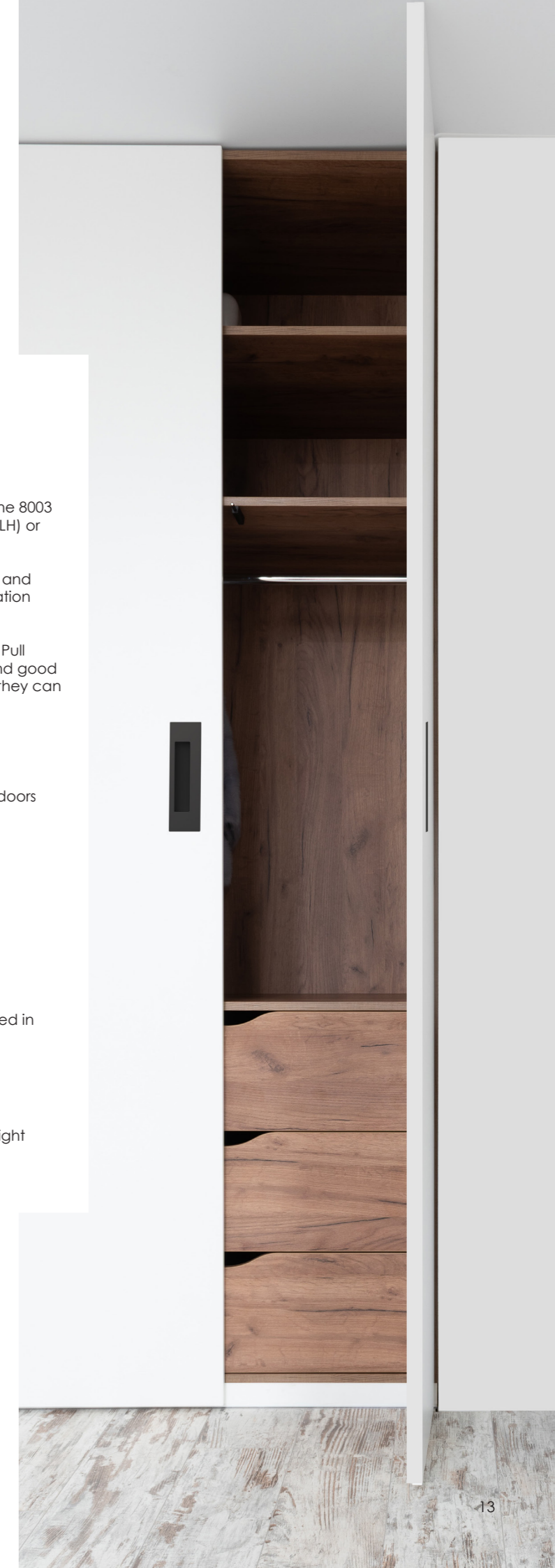



Finishes Guide

Please note: This guide is indicative only - actual finish may vary

<p>BL</p>  <p>BLACK</p>	<p>BN</p>  <p>BRUSHED NICKEL</p>	<p>BR</p>  <p>BRONZE</p>
<p>BRS</p>  <p>SATIN BRASS</p>	<p>BSC</p>  <p>BRUSHED SATIN CHROME</p>	<p>DBR</p>  <p>DARK BRONZE</p>
<p>PC</p>  <p>POLISHED CHROME</p>	<p>SC</p>  <p>SATIN CHROME</p>	<p>WH</p>  <p>WHITE POWDER COATING</p>

The Design Story Behind the M-Series Range by Mardeco

A leading supplier of designer architectural hardware, Mardeco International approached Blender to create a new range of cavity slider hardware. With a huge gap between the top-end products and the cheap, often badly made flush pulls, Mardeco was keen to create a high-quality product without the enormous price tag.

The challenge was designing a product that was versatile enough to handle different types of doors and set itself apart from the many other flush pulls on the market.

M-Series Packaging & Products

Starting with preparing a design brief with the client, the team brainstormed and sketched a range of fresh ideas before developing the strongest ones for customer feedback. Once these ideas were refined and the design direction was set, Blender used the latest 3D CAD tools to create an accurate virtual product model and further develop the finer technical and design details. Using 3D CAD software with a unique modelling technique allowed changes to be made quickly and efficiently along the way. With the latest prototyping technology available, Blender was able to build and test the product quickly throughout the development process. They are leaders in the industry regarding speedy prototyping and testing.

Attention to detail had to be incredibly high for a seemingly simple product. Once a final prototype was built and approved, Blender approached the overseas-based manufacturer.

Blender worked closely with the manufacturer to make final design improvements, improving quality and reducing cost. This guaranteed the best possible product and helped Mardeco reach its goal of creating an affordable product.

Timeless yet modern, simple yet advanced, the new Mardeco m-series range of cavity slider hardware is unique in several ways. It can be used on wooden and aluminium doors of different thicknesses and has interchangeable parts, meaning it can suit a number of different back sets.

Sleek and smooth, it feels like it was made for your hand. The unique lock mechanism looks great and features a fantastic positive locking action. The m-series is exactly what customers have been looking for, as evidenced by the overwhelmingly positive feedback.

Blender also designed instruction manuals, installation videos, packaging and point-of-sale displays for the product.

mardeco[®]

ARCHITECTURAL HARDWARE



See the huge range of quality architectural hardware at your stockist.

Mardeco International Ltd PO Box 131 Whangaparaoa
Auckland New Zealand 0943
Phone: + 64 (0) 9 428 0658 | NZ free phone 0800 820 840 |
info@mardeco.co.nz | www.mardeco.co.nz

Mardeco International Ltd retain the right to change products and specifications without notice.

Please note: Check our website and/or customer portal for the most up-to-date information on finishes and sizes' availability.

DEALER